

SONICA® 5200



21
LITRES

General characteristics

Ultrasonic Cleaning is a safe and efficient modern procedure, which ensures perfect cleaning within the shortest time possible. It has many advantages over ordinary cleaning methods. Ultrasonics can remove even the most tenacious deposits from parts which would be difficult to reach by hand, it also reduces the risk of injury or infection which may occur during manual cleaning



Tank Dimensions

Length	500 mm
Breadth	300 mm
Depth	150 mm
Capacity	21 litres

External Dimensions

Length	600 mm
Breadth	330 mm
Height	425 mm
Weight	about 14 kg

Constructive Materials

External	Steel AISI 304
Internal	Steel AISI 304

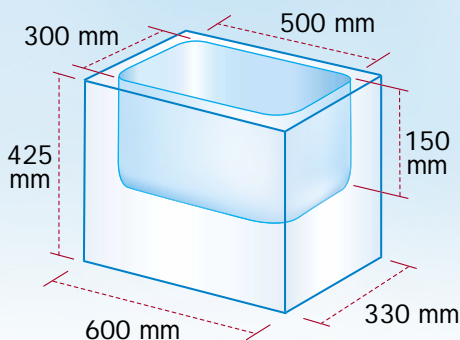

CE EMC 89/336/CEE (EN 55011B)
 LV 73/23/CEE (EN 61010-1)
 MD 93/42/CEE Medical Devices

21
LITRES

SONICA® 5200

Technical Data

Main line voltage	230/240 V ~50/60Hz
Main input power/consumption	400 W
Main input power w/heating	1400 W
Peak HF ultrasound power	800 W
US fequency	40 khz ± 5%
Liquid drain	di serie 1/2"
Transducers	6

Environmental conditions: Temperature

Rel. Hum. 80% up to 31°C. with linear decrease up to 50% at 40°C

Installation category: Class II according to EN 61010

Notes for use as "Medical Devices":

Denomination: Ultrasonic Cleaning Device

UMDNS-nomenclature (ECRI) 14-263

Field of application: cleaning and disinfection of surgical and dental instruments

Classification ((Medical Devices Directive 93/42/EEC, appendix IX):

Class I, Non Active MD, Non Invasive MD, Non Implantable MD

AVAILABLE SERIES



Version M The simplest version in the SONICA® range is equipped with a timer which can be set for to 15 minutes. It can also be set to manual operation..



Version MH This is equipped with a timer wich can be set for un to 15 minutes and can also be set to manual operation. The Thermostat for the heater is set at 60°C.



Version ETH Cleaning times and temperatures controlled electronically by a microprocessor. Waterproof control panel.



Version EP The most technologically advanced of the SONICA® range: new Sweep system generator; modern digital display control panel windows; degas time setting; cleaning times from 0 to 99 minutes; tank liquid temperature setting up to 70°C; memory for 9 cleaning programmes; **jet program** function to start quickly and easily cleaning cycle.

Technical specification subject to change.



SOLTEC S.r.l. Via Castelbarco, 17 - 20136 Milano (Italy)
 Tel. +39 0258308378 - Fax +39 0258308595
 www.soltec.it - e.mail: info@soltec.it



CERTIFICATO N° 04100 20041419